

Data Sheet



Article number: 20883001A

Description: E+G
Spring plunger GN 614-5-KD

Measures

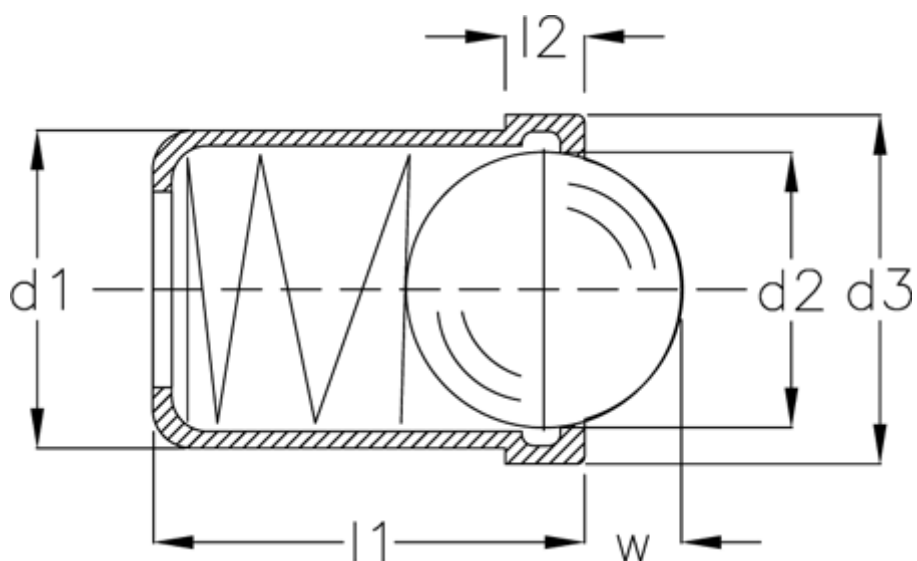

d1	= 5
d2	= 4.0
d3	= 5.6
l1	= 6.0
l2	= 1.0
Spring pressure N bottom	= 9.0
Spring pressure N top	= 4.5
W	= 1.0